

Data Sheet

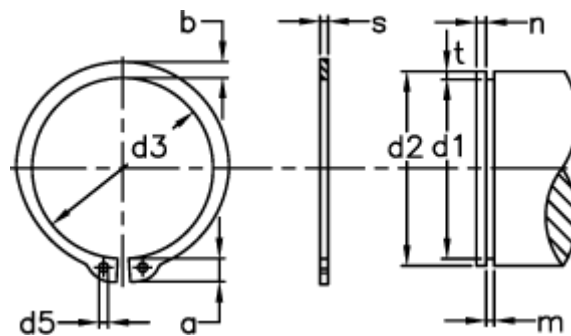

Article number: 0109087
 Description: Retaining ring AS 80x4.0
 Spring steel
 Note: Fitted with ZGA pliers

Measures



a max	= 9.8	Description	= AS 80	s	= 4.00
AN mm ²	= 430.0	FN kN	= 71.60	t	= 1.75
B	= 2.56	FRg kN	= 50.0	tol	= -0.30
b	= 7.4	FR kN	= 328.0	tol	= -0.10
d1	= 76.5	g	= 3.0	tol	= +0,46 -1,10
d2	= 80	m min	= 4.15	Tong	= ZGA-3
d3	= 74.5	n abl x 1000	= 6	Weight kg/1000	= 42.40
d5 min	= 3.0	Nominal drive	= 5.3		